

OSCA D350F 19,700 - 25,000cc*

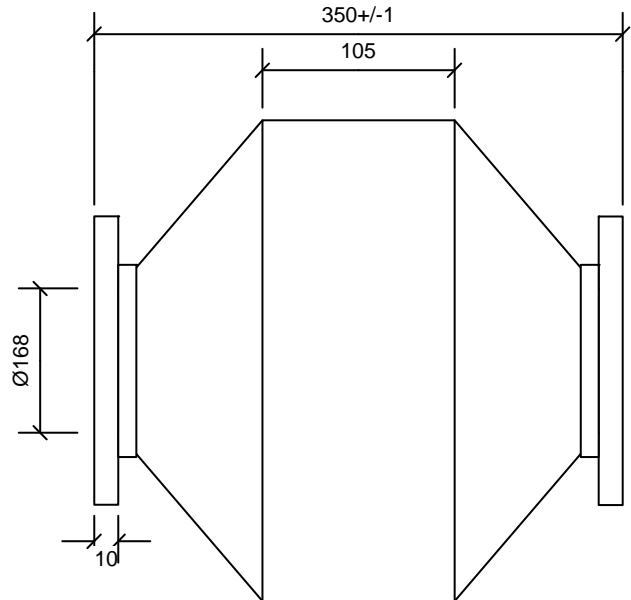
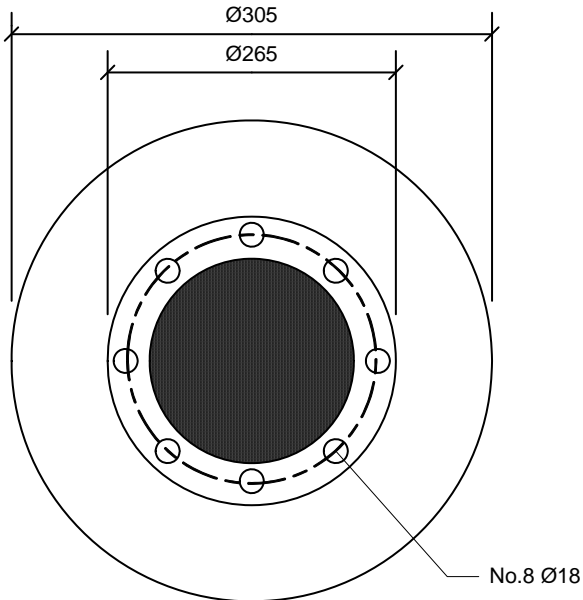

All dimensions in mm
Not to scale

The **OSCA V3NA** Catalytic Converter uses a catalytic chemical conversion to transform carbon monoxide (CO) and unburned hydrocarbons (HC) into non-toxic carbon dioxide and water. This conversion is carried out through a metallic honeycomb substrate coated with platinum, palladium and rhodium. The catalyst is capable of reducing up to 90% of pollutants at an optimum operating temperature of 250°C.

Features

- Up to 90% reduction in pollutants
- Reduces Carbon Monoxide (CO)
- Reduces Unburned Hydrocarbons (HC)
- Effective on Aldehydes
- Suitable for any diesel engine

Fitment

It is essential that fitment is as close as possible to the engine exhaust manifold, the OSCA V3NA requires high temperature to ensure maximum catalytic efficiency. There is no particular direction of flow through the catalyst and should be installed directly in the exhaust line, the original silencer system is left in place.

Efficiency Curve for the OSCA Catalytic Converter

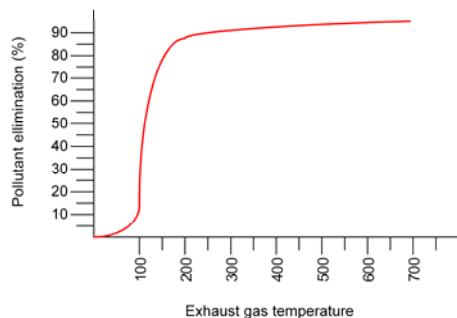

Applications

The catalyst is suited to any diesel engine application, such as prime power or standby generator sets, NRMM such as earth moving equipment and materials handling equipment such as forklifts and telescopic handlers. In particular the catalyst is suited to equipment being used in a confined space such as tunnels, warehouses and mines.

Life

The nature of a catalytic converter is a catalytic reaction; hence the life of the catalyst is theoretically unlimited. Due to unavoidable operating conditions such as engine vibration, poorly tuned engines and abrasive action of the exhaust, the life of the catalyst is reduced. As a result of this, the catalyst requires replacement after 10,000 hours of use.

Maintenance

The catalyst should be cleaned every 500 hours, this is achieved by letting the catalyst cool down after use, removing the honeycomb substrate from the housing and soaking in hot soapy water for 5 hours. The catalyst can be replaced once thoroughly dry.

*For Turbocharged engines first multiply engine displacement by 1.4